

BOROUGH OF CASTLE SHANNON

ORDINANCE NUMBER 875

**AN ORDINANCE OF THE BOROUGH OF CASTLE SHANNON,
ALLEGHENY COUNTY, PENNSYLVANIA, REGULATING THE
PLACEMENT OF WASTE DUMPSTERS AND THE STORAGE OF OTHER
ITEMS WITHIN THE RIGHT-OF-WAY OF ANY PUBLIC STREET IN THE
BOROUGH**

WHEREAS, the Borough Council of the Borough of Castle Shannon, after conducting a public hearing, has determined that it is in the best interests of the Borough of Castle Shannon that the placement of waste dumpsters and the storage of items within the right-of-way of any public street in the Borough be regulated.

NOW, THEREFORE, BE IT ORDAINED AND ENACTED by the Borough Council of the Borough of Castle Shannon, in lawful session duly assembled, and it is hereby ORDAINED AND ENACTED as follows:

Section 1. Legislative Intent.

Dumpsters and portable storage containers are a necessary part of the residential and business community of the Borough of Castle Shannon. If left unregulated, dumpsters and portable storage containers can create problems which can have a detrimental impact on the health, safety, and welfare of the community. Dumpsters and portable storage containers can hinder pedestrian and vehicular traffic flow and create dangerous conditions by obstructing sidewalks and streets and can create an appearance of disorder and economic blight. Council has determined that the regulation of dumpsters and portable storage containers within the Borough will promote the health, safety, and welfare of the community by preventing hazards associated with these devices, by facilitating pedestrian and vehicular traffic flow and by eliminating a nuisance that creates the appearance of inefficiency and economic blight.

Section 2. Definitions.

The following definitions shall apply in the interpretation, administration, and enforcement of this Part:

ACT 97 - the Pennsylvania Solid Waste Management Act of 1980, P.S. 380, No. 97, as now or hereafter amended.

BOROUGH - The Borough of Castle Shannon.

GARBAGE - All table, refuse, animal and vegetable matter, offal from meat, fish and fowls, fruits, vegetable and parts thereof, and other articles and materials ordinarily used for food which have become unfit for such use or which are for any reason

discarded.

HAZARDOUS WASTE - Any garbage, refuse or a combination thereof, as defined in Act 97, which because of its quantity, concentration, or its physical, chemical or infectious characteristics, may:

- a) Cause or significantly contribute to an increase in mortality or an increase in morbidity in either an individual or total population; or
- b) Pose a substantial present or potential hazard to human health or the environment when improperly treated, stored, transported, disposed of or otherwise managed.

PERMITTEE - A person who obtains or is required to obtain a permit under this Part.

PERSON - Any natural person, firm, partnership, corporation, association, limited liability company, estate, trust or other legally recognized entity.

STREET - Any public street, highway, road, lane, court, cul-de-sac, avenue, alley or other thoroughfare within the Borough.

STREET STORAGE - Any item placed in a street for a period in excess of forty-eight (48) consecutive hours that is not a motor vehicle as defined by the Pennsylvania Vehicle Code or a waste dumpster, including, but not limited to, containers commonly known as portable storage devices, stones, mulch, and yard waste.

WASTE DUMPSTER - A unit designed for the deposit of waste materials at or near a building or other structure, commonly located on a temporary basis on a street abutting the site and transportable to and from the site for purposes of disposal of its contents by means of a carrying vehicle.

Section 3. Permit Required.

No person, other than agents or employees of the Borough shall place, maintain or use a waste dumpster or street storage, on public property, including public thoroughfares, without first having obtained a permit from the Borough by filing an application with the Borough in a form to be hereafter prescribed. Any application fee for obtaining such a permit shall be established by ordinance or by resolution of the Borough Council. If the waste dumpster or street storage is or will be located on the street or within the cart way, the placement of the waste dumpster or street storage must be approved by the Chief of Police or his/her designee.

- A. The permit application is considered complete when all required information is provided on the permit application and any applicable fee is paid.
- B. The permit must be issued prior to the placement of the waste dumpster

or street storage by the applicant.

C. All permits issued under this Part shall be valid for a period of ten (10) working days from the date of placement of the waste dumpster or street storage, as stated in the application. If it becomes necessary to amend the date of placement of the waste dumpster or street storage, the applicant shall notify Borough authorities and the ten (10) days will begin with the actual placement of the waste dumpster or street storage.

D. An applicant may apply for an extension of the ten (10) working day period, to be granted by the enforcement official in increments of ten (10) working days, if the enforcement official deems the extension necessary and reasonable. The applicant must apply for an extension at least three (3) days before the expiration of the original permit.

Section 4. Placement and Use Regulations.

A. The placement of a waste dumpster or street storage upon a street shall not extend into the travel lane of traffic.

B. A waste dumpster or street storage placed upon a street shall be illuminated with a warning light, light reflector or a reflectorized material on the front and rear surfaces in such a manner to indicate the height and width of it, and shall be visible for a distance of not less than three hundred (300') feet between the hours of sunset and sunrise.

C. The location and utilization of a waste dumpster or street storage upon a street shall not be in a manner which constitutes a safety hazard to persons or property.

D. The location and utilization of a waste dumpster or street storage upon a street shall be in compliance with all federal, state and local laws, rules and regulations applicable thereto, including but not limited to any highway occupancy or other permit required by the Pennsylvania Department of Transportation, in addition to the requirements of this Part.

E. The waste dumpster or street storage shall be kept at least 20 feet away from any crosswalk and from any intersection and must be placed so it does not block the view of any motorist pulling into a roadway.

F. The waste dumpster or street storage shall be conspicuously marked with the name, address and phone number of its owner and a copy of the current effective permit shall be visibly attached to it.

G. During all times when the waste dumpster or street storage is in place and in use, a tarpaulin or other suitable weather resistant cover shall be placed over it in order to protect the contents from being displaced and/or causing litter on public

property or a private premises or creating dust, offensive odors or other health hazards. In all instances, the container shall, when necessary, be provided with adequate restraints to prevent inadvertent movement from its original location. The need for restraints shall be determined by Borough officials at the time the permit is issued.

H. No overflow of any material shall be permitted from the waste dumpster or street storage, nor shall any accumulation of any material next to the waste dumpster or street storage be permitted.

I. Hazardous waste and garbage shall not be stored in a waste dumpster or street storage.

J. There shall be no defect or faulty design in the waste dumpster or street storage, which might create a hazard to the general public, interfere with its operation or inhibit the purpose for which it is to be used.

K. Liability insurance shall be obtained and maintained by the permittee in the amount of at least five hundred thousand dollars (\$100,000) for property damage and personal injury, combined single limit, arising out of or in connection with the placement or utilization of a waste dumpster or street storage on any street, with the Borough being named as an additional insured on said policy for such purpose.

L. The permittee shall execute an indemnity agreement, in a form acceptable to the Borough, promising to indemnify, save harmless and defend the Borough, its officials, agents, servants, and employees and each of them, against and hold it and them harmless from any and all lawsuits, claims, demands, liabilities, losses and expenses, including court costs and reasonable attorneys' fees for or on account of any injury to any person or any damage to any property, which may arise or which may be alleged to have arisen out of or in connection with the placement or utilization of a waste dumpster or street storage on any street.

M. Only one (1) waste dumpster or street storage per property will be permitted on any street in the Borough.

N. If a chute or similar device or object is to be used with a waste dumpster, it must be deemed structurally sound by the Borough or its designee, and liability insurance in the same amount and form as set forth in Subsection K above shall be provided.

O. The permittee shall assume all risk of damage, and the Borough shall not be liable for any damage, to the waste dumpster or street storage when the Borough is plowing snow, maintaining the street or other facilities within the street or performing other public functions.

P. The permittee shall be responsible for all damages to Borough property which may occur as a result of the placement or use of the dumpster or street storage.

If the permittee does not promptly repair any damage after notice to do so from the Borough, the Borough may repair such damage and recover the cost from the permittee.

Section 5. Revocation of Permit.

Without limitation as to the utilization of any other legal or equitable remedy or action available to the Borough, civil or criminal, noncompliance with any of the requirements or provisions set forth in this Part or any material false statement or omission made in connection with the application for a permit shall be grounds for revocation by the Borough Manager, the Borough Chief of Police or their designee of the permit issued pursuant to this Part.

Section 6. Removal of Waste Dumpsters or Street Storage.

The Borough may at the expense of the owner or lessee of the property or the permittee remove or cause the removal of a waste dumpster or street storage.

Section 7. Penalties.

Any person who or which violates or fails to comply with any provision of this Part shall, upon conviction, be sentenced to pay a fine of not less than Two Hundred (\$200.00) Dollars and not more than Six Hundred (\$600.00) Dollars plus costs for each such violation. Each day or portion thereof in which a violation exists shall be considered a separate violation of this Part. Each provision of this Part which is violated shall be considered a separate violation. Such fine shall be in addition to any other fine which may be imposed under the provisions of any other ordinances of the Borough, Pennsylvania law, or Federal law. In default of payment of any fine, such person shall be imprisonment for not more than thirty (30) days.

Section 8. Equitable Relief.

In addition to or in lieu of the penalties provided in Section 7 hereof, any violations of the provisions of this Part may be abated or enforced by proceedings seeking equitable relief against the violator.

Section 9.

Any ordinance or part of ordinance conflicting with the provisions of this ordinance are hereby repealed to the extent of such conflict.

Section 10.

Nothing in this Ordinance shall be construed to affect any suit or proceeding pending in any court, or any rights acquired, or liability incurred, or any cause or causes of action acquired or existing, under any act or ordinance hereby repealed as cited in Section 3 of this Ordinance; nor shall any just or legal right or remedy of any character be lost, impaired or affected by this Ordinance.

Section 11.

If any provision of this ordinance shall be determined to be unlawful, invalid, void or unenforceable, then that provision shall be considered severable from the remaining provisions which shall continue in full force and effect.

Section 12.

This ordinance shall be in full force and effect immediately upon and after its final passage.

ORDAINED AND ENACTED into law this 25 day of October,
2010.

ATTEST

Thomas C. Hartswick
Borough Manager/Secretary

BOROUGH OF CASTLE SHANNON

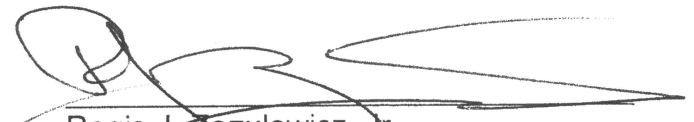
Regis J. Zezulewicz, Jr.
President of Council

Examined and approved this
25 day of October, 2010.

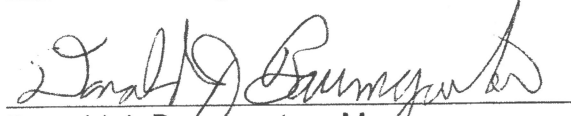
Donald J. Baumgarten, Mayor

Approved as to Form

Dennis R. Biondo, Solicitor

**BOROUGH OF CASTLE SHANNON
REQUEST FOR TEMPORARY PLACEMENT OF DUMPSTER/CONTAINER ON A ROADWAY**

(\$50 fee made payable to Castle Shannon Borough)

REQUESTOR INFORMATION

Name: _____
Address: _____
Email Address: _____ Phone: _____
Homeowner's Insurance Carrier: _____
Policy Number: _____

DUMPSTER COMPANY INFORMATION

Name: _____
Address: _____
Contact Name: _____ Phone Number: _____
Insurance Carrier: _____
Policy Number: _____

Dumpster Location: _____
Date of Placement: _____ Estimated Time of Placement From: _____ To: _____
Type of Traffic Controls: (cones, drums, lighting, etc.) _____

Requestor agrees to assume all costs and responsibilities for the placement and maintenance of Traffic Control Devices required to alert and warn drivers of the potential hazards created by the placement of the dumpster/container. In addition, the requestor agrees to fully indemnify and hold harmless the Borough of Castle Shannon and assumes all liability for damages or injury occurring to any person or property through or in consequence of any act or omission of anyone associated with the placement of the dumpster/container on the roadway. Requestor has obtained minimum \$100,000 liability insurance, and names the Borough of Castle Shannon as an additional insured on said policy for such purpose.

Name (printed): _____ Signature: _____
Date: _____

Request has been examined by Chief of Police or his designee and recommends:

Approved

Denied

Reason for Denial: _____

Name of Official: _____ Date: _____

Signature: _____

DUMPSTER/CONTAINER CRITERIA FOR PLACEMENT
CASTLE SHANNON BOROUGH

The placement of a dumpster/container on a roadway within the Borough of Castle Shannon may be permitted providing the following criteria are satisfied:

1. The requestor has no other available space (driveway, lawn, etc..) that the dumpster can be placed.
2. The dumpster/container will not be placed on the roadway longer than 10 days.
3. The dumpster/container will be removed within 24 hours of it being filled.
4. The dumpster/container will be secured so as to prevent debris from the container from blowing from or spilling from the container.
5. Traffic control devices will be properly placed and maintained to alert and warn drivers of the potential hazards created by the placement of the container.
6. The requestor completes an application requesting the placement of the dumpster/ container and agrees to the conditions and requirements associated with such request.
7. The requestor pays a **\$50.00** application fee.
8. The request is approved by the Chief of Police or his designee.

NO dumpster/container will be allowed to be placed in any area that a motor vehicle would be prohibited from stopping, standing or parking by either ordinance or statute.

(Unless articulable circumstances present and only upon approval of Chief of Police or designee)

Traffic Control Devices:

1. Traffic control devices shall be placed when the dumpster/container is placed on the roadway, and they shall be properly maintained during the time they are placed.
2. Traffic control devices shall remain in place only as long as they are needed, and they shall be removed as soon as possible thereafter.
3. Traffic control devices shall be correctly positioned, clean, legible, operative, and in good state of repair. The reflective sheeting is not permitted to be scratched, scarred dirty or show evidence of loss of reflectivity. They shall be repositioned, cleaned repaired, and replaced when necessary to maintain their effectiveness.
4. Devices shall be positioned to provide for a smooth and gradual transition of traffic around the dumpster/container.
5. Devices shall be constructed so as not to inflict undue damage to a vehicle that strikes them inadvertently.
6. Only cones (28"to36"), drums, Type I or II Barricades, or minicades shall be used as traffic control devices. Devices shall have reflective sheeting.
7. At a minimum, there shall be at least 4 (four) devices positioned in front of the dumpster /container, as shown in the attached diagram, and 2 (two) devices behind.
8. In addition to the traffic control devices, the dumpster must display reflective material mounted on each of its corners.

ROADWAY

TRAFFIC CONTROL DEVICES

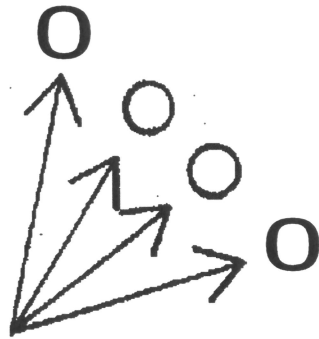
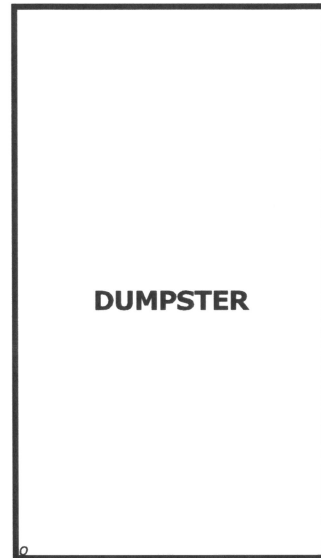

TRAFFIC CONTROL DEVICES

Figure 6F-7. Channelizing Devices

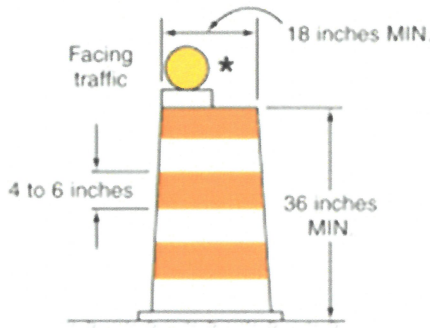

DRUM

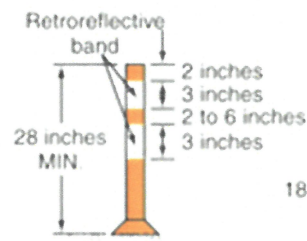

Night and/or freeway
High-speed roadway
(≥ 45 mph)

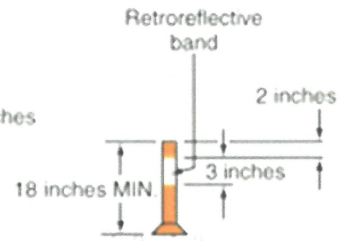

Day and low-speed
roadway (≤ 40 mph)

TUBULAR MARKERS

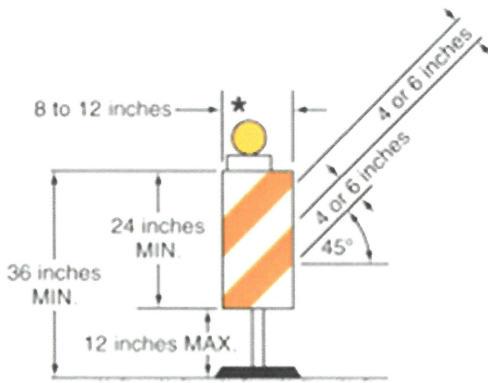

VERTICAL PANEL

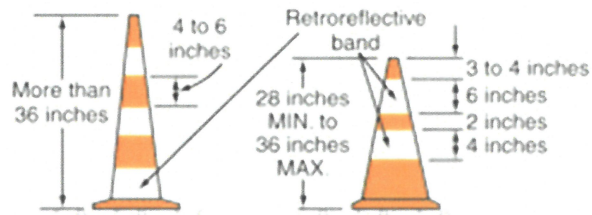

Night and/or freeway
High-speed roadway
(≥ 45 mph)

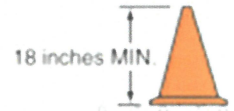

Day and low-speed
roadway (≤ 40 mph)

CONES

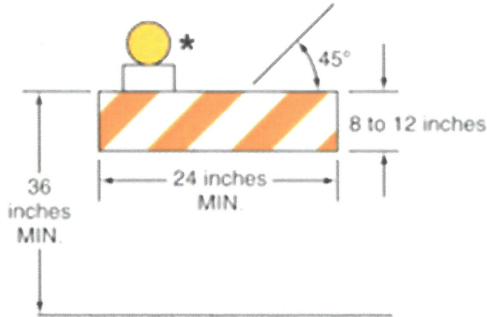

TYPE 1 BARRICADE **

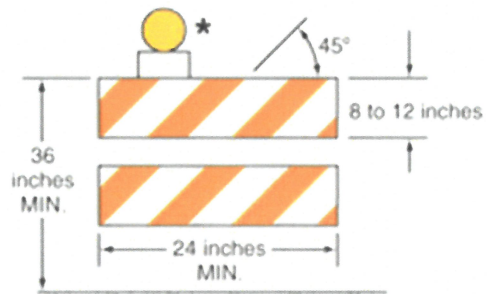

TYPE 2 BARRICADE **

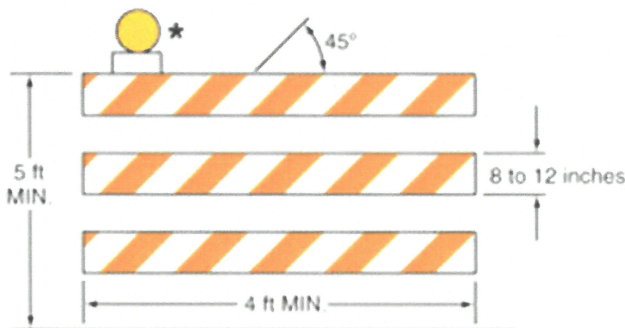

TYPE 3 BARRICADE **

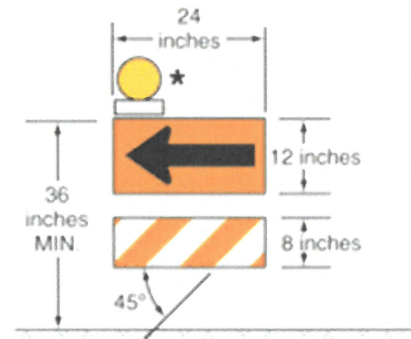

DIRECTION INDICATOR BARRICADE **

* Warning lights (optional)

** Rail stripe widths shall be 6 inches, except that 4-inch wide stripes may be used if rail lengths are less than 36 inches. The sides of barricades facing traffic shall have retroreflective rail faces.